



ELECTROMAGNETIC COMPLIANCE TEST REPORT

For

SOA

Model: K3-A1

Brand Name: N/A

Report No.: ENC2304274GZ62E1

Date of Issue: May 5, 2023

Prepared For

Guangzhou BBI Photoelectric Technology Co.,Ltd

**11/F, Building 1, Haihua Science & Technology Innovation Park, No. 62 Jinghu
Avenue, Huadu District, Guangzhou, China**

Prepared By

East Notice Certification Service Co., Ltd.

**1/F, Haohui Commercial Building, Zhuji Street, Dongpu Town, Tianhe District,
Guangzhou City, China**

TEL: +86-20-8256 8534

FAX: +86-20-8256 8534

The results shown in this test report refer only to the sample(s) tested unless otherwise stated and the sample(s) are retained for 30 days only. The document is issued by ENC, this document cannot be reproduced except in full with our prior written permission. The document is available on request and the brief information for its validation can be assessable and confirmed at <http://www.enc-lab.com>.

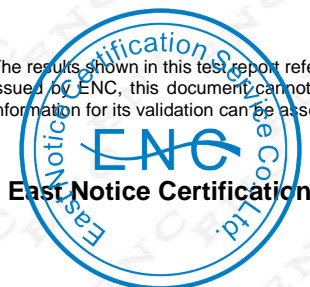

1/F, Haohui Commercial Building, Zhuji Street,
Dongpu Town, Tianhe District, Guangzhou City

Tel:+86-020-8256 8534
E-mail: enc@enc-lab.com

Fax:+86-020-8256 8534
[Http:// www.enc-lab.com](http://www.enc-lab.com)

TABLE OF CONTENTS

1. VERIFICATION OF CONFORMITY	3
2. SYSTEM DESCRIPTION AND PRODUCT INFORMATION	4
3. TEST SUMMARY	5
4. SUPPORT EQUIPMENT	6
5. TEST FACILITY	7
6. EN IEC 55014-1 LINE CONDUCTED EMISSION TEST	8
6.1. TEST EQUIPMENT OF CONDUCTED EMISSION TEST	8
6.2. LIMITS OF LINE CONDUCTED EMISSION TEST	8
6.3. BLOCK DIAGRAM OF TEST SETUP	8
6.4. PROCEDURE OF LINE CONDUCTED EMISSION TEST	9
6.5. TEST RESULT OF LINE CONDUCTED EMISSION TEST	10
7. EN IEC 55014-1 DISTURBANCE POWER EMISSION TEST	12
7.1. TEST EQUIPMENT OF DISTURBANCE POWER EMISSION TEST	12
7.2. LIMITS OF DISTURBANCE POWER EMISSION TEST	12
7.3. BLOCK DIAGRAM OF TEST SETUP	12
7.4. SUMMARY DATA OF DISTURBANCE POWER EMISSION TEST	13
8. EN IEC 61000-3-2 POWER HARMONICS TEST	14
8.1. TEST EQUIPMENT OF POWER HARMONICS TEST	14
8.2. BLOCK DIAGRAM OF TEST SETUP	14
8.3. LIMITS OF HARMONIC CURRENT.....	14
8.4. RESULT	16
9. EN 61000-3-3 VOLTAGE FLUCTUATION / FLICKER TEST	17
9.1. TEST EQUIPMENT OF VOLTAGE FLUCTUATION / FLICKER TEST	17
9.2. BLOCK DIAGRAM OF TEST SETUP	17
9.3. RESULT	18
10. IEC 61000-4-2 ESD IMMUNITY TEST	19
10.1. TEST EQUIPMENT OF ESD TEST	19
10.2. BLOCK DIAGRAM OF TEST SETUP	19
10.3. TEST PROCEDURE	19

The results shown in this test report refer only to the sample(s) tested unless otherwise stated and the sample(s) are retained for 30 days only. The document is issued by ENC, this document cannot be reproduced except in full with our prior written permission. The document is available on request and the brief information for its validation can be assessable and confirmed at <http://www.enc-lab.com>.

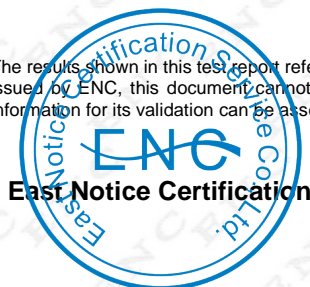

10.4. PERFORMANCE & RESULT	20
11. IEC 61000-4-3 TEST	21
11.1. TEST EQUIPMENT	21
11.2. BLOCK DIAGRAM OF TEST SETUP	21
11.3. TEST PROCEDURE	22
11.4. PERFORMANCE & RESULT	22
12. IEC 61000-4-4 TEST	23
12.1. TEST EQUIPMENT	23
12.2. BLOCK DIAGRAM OF TEST SETUP	23
12.3. TEST PROCEDURE	24
12.4. PERFORMANCE & RESULT	24
13. IEC 61000-4-5 SURGE IMMUNITY TEST	25
13.1. TEST EQUIPMENT OF SURGE TEST	25
13.2. BLOCK DIAGRAM OF TEST SETUP	25
13.3. TEST PROCEDURE	26
13.4. PERFORMANCE & RESULT	26
14. IEC 61000-4-6 TEST	27
14.1. TEST EQUIPMENT	27
14.2. BLOCK DIAGRAM OF TEST SETUP	27
14.3. TEST PROCEDURE	28
14.4. PERFORMANCE & RESULT	28
15. IEC 61000-4-11 TEST	29
15.1. TEST EQUIPMENT	29
15.2. BLOCK DIAGRAM OF TEST SETUP	29
15.3. TEST PROCEDURE	30
15.4. PERFORMANCE	30
APPENDIX 1	31
PHOTOGRAPHS OF EUT	31

The results shown in this test report refer only to the sample(s) tested unless otherwise stated and the sample(s) are retained for 30 days only. The document is issued by ENC, this document cannot be reproduced except in full with our prior written permission. The document is available on request and the brief information for its validation can be assessable and confirmed at <http://www.enc-lab.com>.

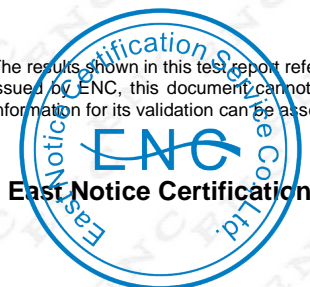

1. VERIFICATION OF CONFORMITY

Equipment Under Test:	SOA
Model:	K3-A1
Model Difference:	N/A
Brand Name:	N/A
Applicant:	Guangzhou BBI Photoelectric Technology Co.,Ltd 11/F, Building 1, Haihua Science & Technology Innovation Park, No. 62 Jinghu Avenue, Huadu District, Guangzhou, China
Manufacturer:	Guangzhou BBI Photoelectric Technology Co.,Ltd 11/F, Building 1, Haihua Science & Technology Innovation Park, No. 62 Jinghu Avenue, Huadu District, Guangzhou, China
Type of Test:	EMC Directive 2014/30/EU for CE Marking
Technical Standards:	EN IEC 55014-1:2021 EN IEC 61000-3-2:2019+A1:2021 EN 61000-3-3:2013+A1:2019+A2:2021 EN IEC 55014-2:2021
File Number:	ENC2304274GZ62E1
Date of test:	Apr. 27, 2023 – May 5, 2023
Deviation:	None
Condition of Test Sample:	Normal

The above equipment was tested for compliance with the requirements set forth in EMC Directive 2014/30/EU and the Technical Standards mentioned above. This said equipment in the configuration described in this report shows the maximum emission levels emanating from equipment and the level of the immunity endurance of the equipment are within the compliance requirements.

Should any objections to the test reports occurred, should submit it to the Company within ten days since the issuing of the report, Fail to accept.

The test results of this report relate only to the tested Sample identified in this report.

Checked By Yemig
Yemig May 5, 2023

Authorized By Ray Zhou
Ray Zhou May 5, 2023



The results shown in this test report refer only to the sample(s) tested unless otherwise stated and the sample(s) are retained for 30 days only. The document is issued by ENC, this document cannot be reproduced except in full with our prior written permission. The document is available on request and the brief information for its validation can be assessable and confirmed at <http://www.enc-lab.com>.

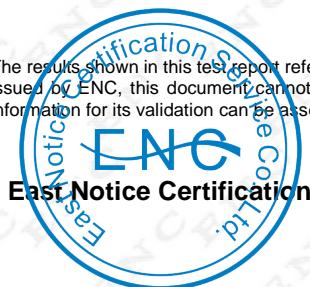

2. SYSTEM DESCRIPTION AND PRODUCT INFORMATION

SYSTEM DESCRIPTION

EUT Test Procedure:

1. Connect EUT and peripheral devices if need.
2. Power on the EUT, the EUT begins to work.
3. Make sure the EUT operates normally during the test.

PRODUCT INFORMATION

Housing Type : Metal & Plastic
Rated Voltage : 220-240V~, 50Hz
Rated Power : 750W
Protection Class : I

I/O Port Information (Applicable Not Applicable)

I/O Port of EUT			
I/O Port Type	Q'TY	Cable	Tested with
AC input port	1	1.5 m unshielded	1

The results shown in this test report refer only to the sample(s) tested unless otherwise stated and the sample(s) are retained for 30 days only. The document is issued by ENC, this document cannot be reproduced except in full with our prior written permission. The document is available on request and the brief information for its validation can be assessable and confirmed at <http://www.enc-lab.com>.

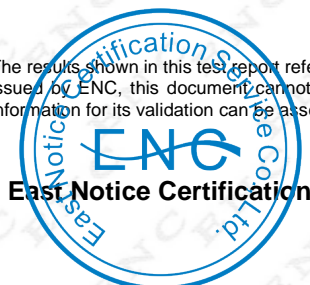

3. TEST SUMMARY

Test	Test Requirement	Test Method	Class / Severity	Result
Emissions				
Conducted Emission	EN IEC 55014-1:2021	EN IEC 55014-1:2021	Class B	PASS
Disturbance Power emission	EN IEC 55014-1:2021	EN IEC 55014-1:2021	Class B	PASS
Harmonic Emission	EN IEC 61000-3-2:2019+A1:2021	EN IEC 61000-3-2:2019+A1:2021	Class A	PASS
Voltage Fluctuations & Flicker	EN 61000-3-3:2013 +A1:2019+A2:2021	EN 61000-3-3:2013 +A1:2019+A2:2021	Clause 5 of EN61000-3-3	PASS
Immunity				
Electrostatic Discharge (ESD)	EN IEC 55014-2:2021	IEC 61000-4-2:2008	B	PASS
RF Electromagnetic Field	EN IEC 55014-2:2021	IEC 61000-4-3:2020	A	PASS
Electrical Fast Transients (EFT)	EN IEC 55014-2:2021	IEC 61000-4-4:2012	B	PASS
Surge Immunity	EN IEC 55014-2:2021	IEC 61000-4-5:2017	B	PASS
Injected Current Immunity	EN IEC 55014-2:2021	IEC 61000-4-6:2013	A	PASS
Power Frequency Magnetic Field	EN IEC 55014-2:2021	IEC 61000-4-8:2009	A	PASS
Volt. Interruptions Volt. Dips	EN IEC 55014-2:2021	IEC 61000-4-11:2020	C/C/C Note (2)	PASS

Note:

- (1) "NA" denotes test is not applicable in this Test Report
- (2) Voltage dip: 0% reduction - Performance Criteria C
Voltage dip: 30% reduction - Performance Criteria C
Voltage dip: 60% reduction - Performance Criteria C
- (3) For client's request and manual description, the test will not be executed.

The results shown in this test report refer only to the sample(s) tested unless otherwise stated and the sample(s) are retained for 30 days only. The document is issued by ENC, this document cannot be reproduced except in full with our prior written permission. The document is available on request and the brief information for its validation can be assessable and confirmed at <http://www.enc-lab.com>.

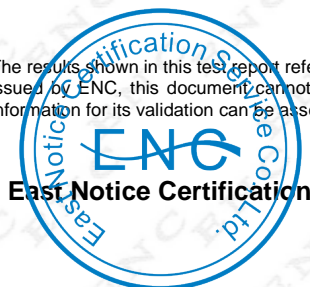



4. SUPPORT EQUIPMENT

Device Type	Manufacturer	Model Name	Serial No.	Data Cable	Power Cable
--	--	--	--	--	--

****Note:** All the above equipment/cables were placed in worse case positions to maximize emission signals during emission test.

Grounding: Grounding was in accordance with the manufacturer's requirements and conditions for the intended use.

The results shown in this test report refer only to the sample(s) tested unless otherwise stated and the sample(s) are retained for 30 days only. The document is issued by ENC, this document cannot be reproduced except in full with our prior written permission. The document is available on request and the brief information for its validation can be assessable and confirmed at <http://www.enc-lab.com>.

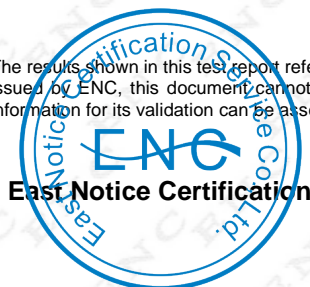



5. TEST FACILITY

Location: 1/F, Haohui Commercial Building, Zhuji Street, Dongpu Town, Tianhe District, Guangzhou City, China

Description: There is one 3m semi-anechoic an area test sites and two line conducted labs for final test. The Open Area Test Sites and the Line Conducted labs are constructed and calibrated to meet the FCC requirements in documents ANSI C63.4 and CISPR 14/EN IEC 55014 requirements.

Site Filing: The site description is on file with the Federal Communications Commission, 7435 Oakland Mills Road, Columbia, MD 21046.

Instrument Tolerance: All measuring equipment is in accord with ANSI C63.4 and CISPR 14 requirements that meet industry regulatory agency and accreditation agency requirement.

The results shown in this test report refer only to the sample(s) tested unless otherwise stated and the sample(s) are retained for 30 days only. The document is issued by ENC, this document cannot be reproduced except in full with our prior written permission. The document is available on request and the brief information for its validation can be assessable and confirmed at <http://www.enc-lab.com>.

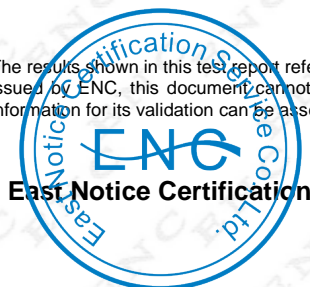

6. EN IEC 55014-1 LINE CONDUCTED EMISSION TEST

6.1. TEST EQUIPMENT OF CONDUCTED EMISSION TEST

Description	Manufacturer	Model	Identifier	Cal. Date	Cal. Due
Spectrum Analyzer	Aeroflex	2399A	N/A	15/02/2023	14/02/2024
LISN	HAMEG	HM6050-2	N/A	15/02/2023	14/02/2024

6.2. LIMITS OF LINE CONDUCTED EMISSION TEST

Frequency	Maximum RF Line Voltage	
	Q.P.(dBuV)	Average(dBuV)
150kHz-500kHz	66-56	56-46
500kHz-5MHz	56	46
5MHz-30MHz	60	50

****Note:** 1. The lower limit shall apply at the transition frequency.

2. The limit decreases linearly with the logarithm of the frequency in the range 0.15 MHz to 0.50 MHz

6.3. BLOCK DIAGRAM OF TEST SETUP

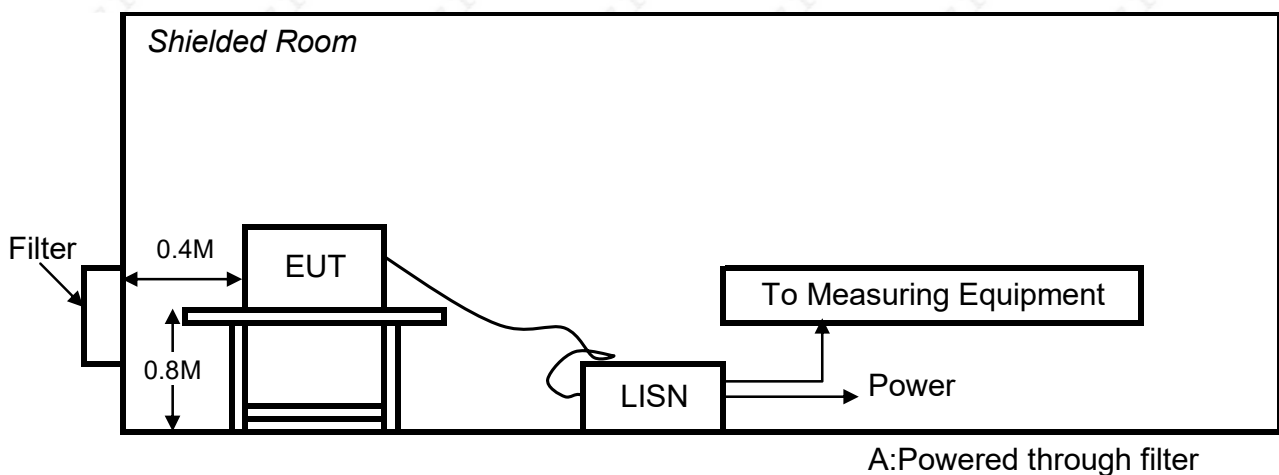

The results shown in this test report refer only to the sample(s) tested unless otherwise stated and the sample(s) are retained for 30 days only. The document is issued by ENC, this document cannot be reproduced except in full with our prior written permission. The document is available on request and the brief information for its validation can be assessable and confirmed at <http://www.enc-lab.com>.

6.4. PROCEDURE OF LINE CONDUCTED EMISSION TEST

- 1) The equipment was set up as per the test configuration to simulate typical actual usage per the user's manual. When the EUT is a tabletop system, a wooden table with a height of 0.8 meters is used and is placed on the ground plane as per EN IEC 55014-1 (see Test Facility for the dimensions of the ground plane used). When the EUT is a floor-standing equipment, it is placed on the ground plane which has a 3-12 mm non-conductive covering to insulate the EUT from the ground plane.
- 2) Support equipment, if needed, was placed as per EN IEC 55014-1
- 3) All I/O cables were positioned to simulate typical actual usage as per EN IEC 55014-1
- 4) The EUT received AC230V/50Hz power through a Line Impedance Stabilization Network (LISN) which supplied power source and was grounded to the ground plane.
- 5) All support equipments received power from a second LISN supplying power of AC 230V/50Hz, if any.
- 6) The EUT test program was started. Emissions were measured on each current carrying line of the EUT using a spectrum Analyzer / Receiver connected to the LISN powering the EUT. The LISN has two monitoring points: Line 1 (Hot Side) and Line 2 (Neutral Side). Two scans were taken: one with Line 1 connected to Analyzer / Receiver and Line 2 connected to a 50 ohm load; the second scan had Line 1 connected to a 50 ohm load and Line 2 connected to the Analyzer / Receiver.
- 7) Analyzer / Receiver scanned from 150 kHz to 30 MHz for emissions in each of the test modes.
- 8) During the above scans, the emissions were maximized by cable manipulation.
- 9) A scan was taken on both power lines, Line 1 and Line 2, recording at least the six highest emissions.
- 10) Emission frequency and amplitude were recorded into a computer in which correction factors were used to calculate the emission level and compare reading to the applicable limit. If EUT emission level was less -2dB to the A.V. limit in Peak mode, then the emission signal was re-checked using Q.P and Average detector.

The test data of the worst case condition(s) was reported on the Summary Data page.

The results shown in this test report refer only to the sample(s) tested unless otherwise stated and the sample(s) are retained for 30 days only. The document is issued by ENC, this document cannot be reproduced except in full with our prior written permission. The document is available on request and the brief information for its validation can be assessable and confirmed at <http://www.enc-lab.com>.

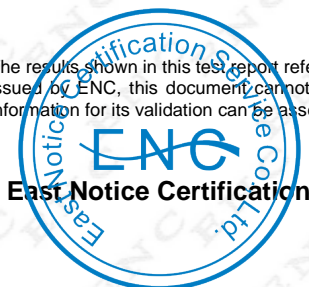

6.5. TEST RESULT OF LINE CONDUCTED EMISSION TEST

EUT : SOA
M/N : K3-A1
Mode : Normal, L

Power : AC230V
Temperature : 25°C
Humidity : 54%

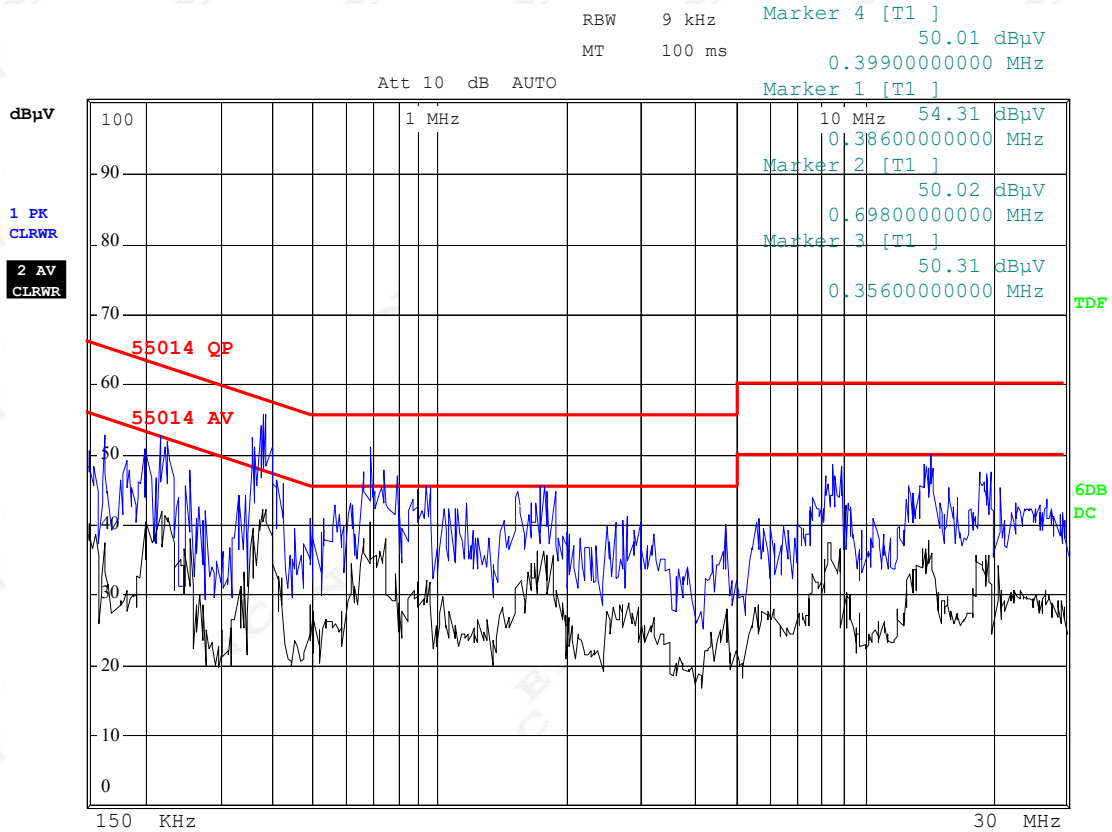

RESULT: PASS

The results shown in this test report refer only to the sample(s) tested unless otherwise stated and the sample(s) are retained for 30 days only. The document is issued by ENC, this document cannot be reproduced except in full with our prior written permission. The document is available on request and the brief information for its validation can be assessable and confirmed at <http://www.enc-lab.com>.





EUT : SOA
M/N : K3-A1
Mode : Normal, N

Power : AC230V
Temperature : 25°C
Humidity : 54%

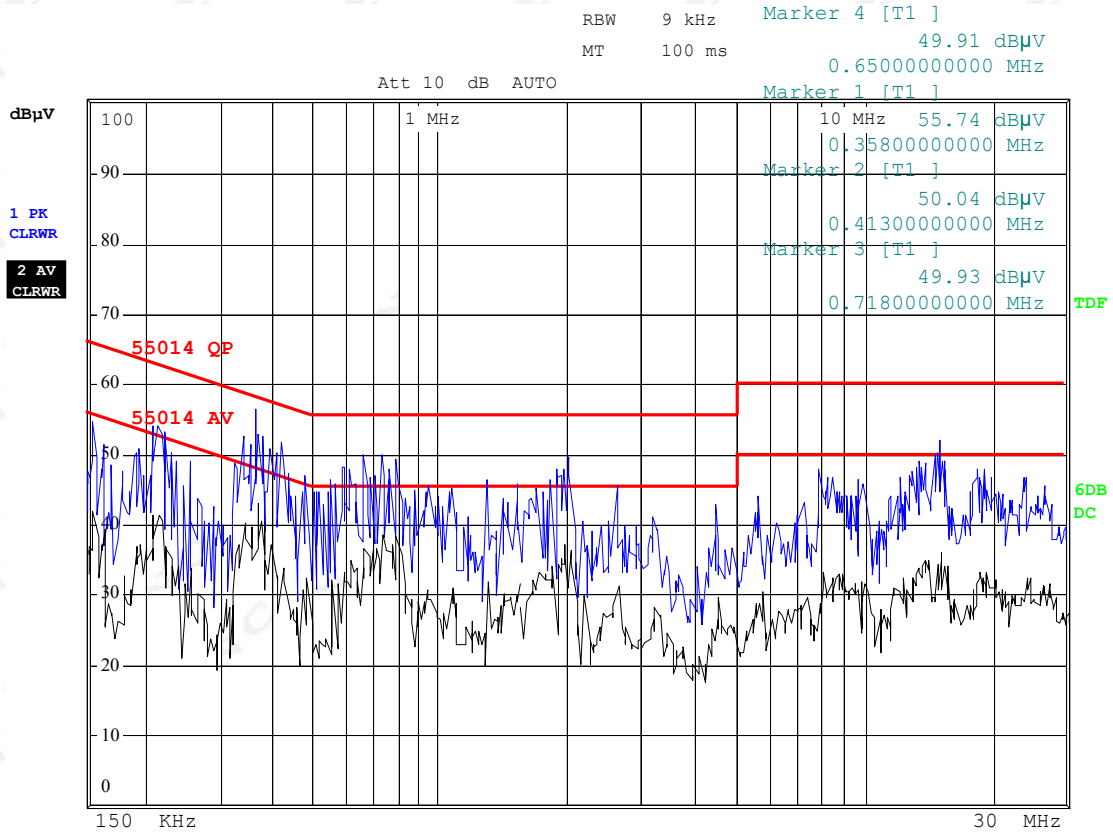

RESULT: PASS

The results shown in this test report refer only to the sample(s) tested unless otherwise stated and the sample(s) are retained for 30 days only. The document is issued by ENC, this document cannot be reproduced except in full with our prior written permission. The document is available on request and the brief information for its validation can be assessable and confirmed at <http://www.enc-lab.com>.



7. EN IEC 55014-1 DISTURBANCE POWER EMISSION TEST

7.1. TEST EQUIPMENT OF DISTURBANCE POWER EMISSION TEST

Description	Manufacturer	Model	Identifier	Cal. Date	Cal. Due
Test Receiver	R&S	CISPR16	N/A	15/02/2023	14/02/2024
Absorbing Clamp	CSI	CLA-050	N/A	15/02/2023	14/02/2024
Cable	TS	TS@90	N/A	15/02/2023	14/02/2024

7.2. LIMITS OF DISTURBANCE POWER EMISSION TEST

Equipment Type	Frequency (MHz)	Limit Values dB(pW)	
		Quasi-peak	Average
Associated equipment	30-300	45-55	35-45
Increasing linearly with the frequency			

7.3. BLOCK DIAGRAM OF TEST SETUP

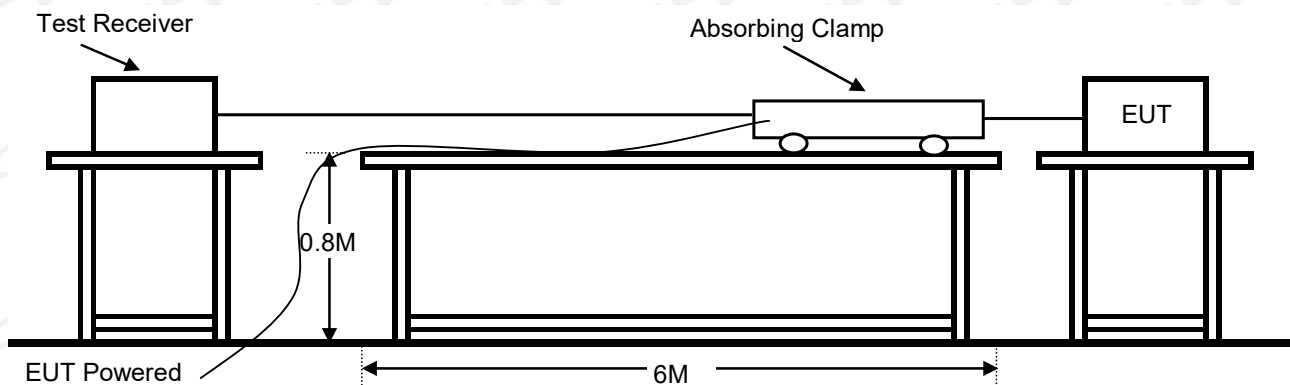

Note:

EUT is placed on a non-metallic table of 0.1 m of height above the floor and at least 0.8m from other metallic objects and from any person. The lead to be measured shall be stretched in a straight horizontal line for length sufficient to accommodate the absorbing clamp.

The absorbing clamp is placed around the lead to be measured, with its current transformer towards the equipment under test.

All connectors not used shall be left un-terminated. All connectors having a connected lead shall be terminated in a manner representative of use.

The absorbing clamp is applied successively to all leads whose length is 25cm or longer, unscreened or screened, which may be connected to the individual units of the equipment under test.

At each test frequency the absorbing clamp shall be moved along the lead until the maximum value is found between a position adjacent to the equipment under test and a distance of about a half wavelength from it.

The results shown in this test report refer only to the sample(s) tested unless otherwise stated and the sample(s) are retained for 30 days only. The document is issued by ENC, this document cannot be reproduced except in full with our prior written permission. The document is available on request and the brief information for its validation can be assessable and confirmed at <http://www.enc-lab.com>.

7.4. SUMMARY DATA OF DISTURBANCE POWER EMISSION TEST

EUT	: SOA	Power	: AC230V
M/N	: K3-A1	Temperature	: 25°C
Mode	: Normal	Humidity	: 54%

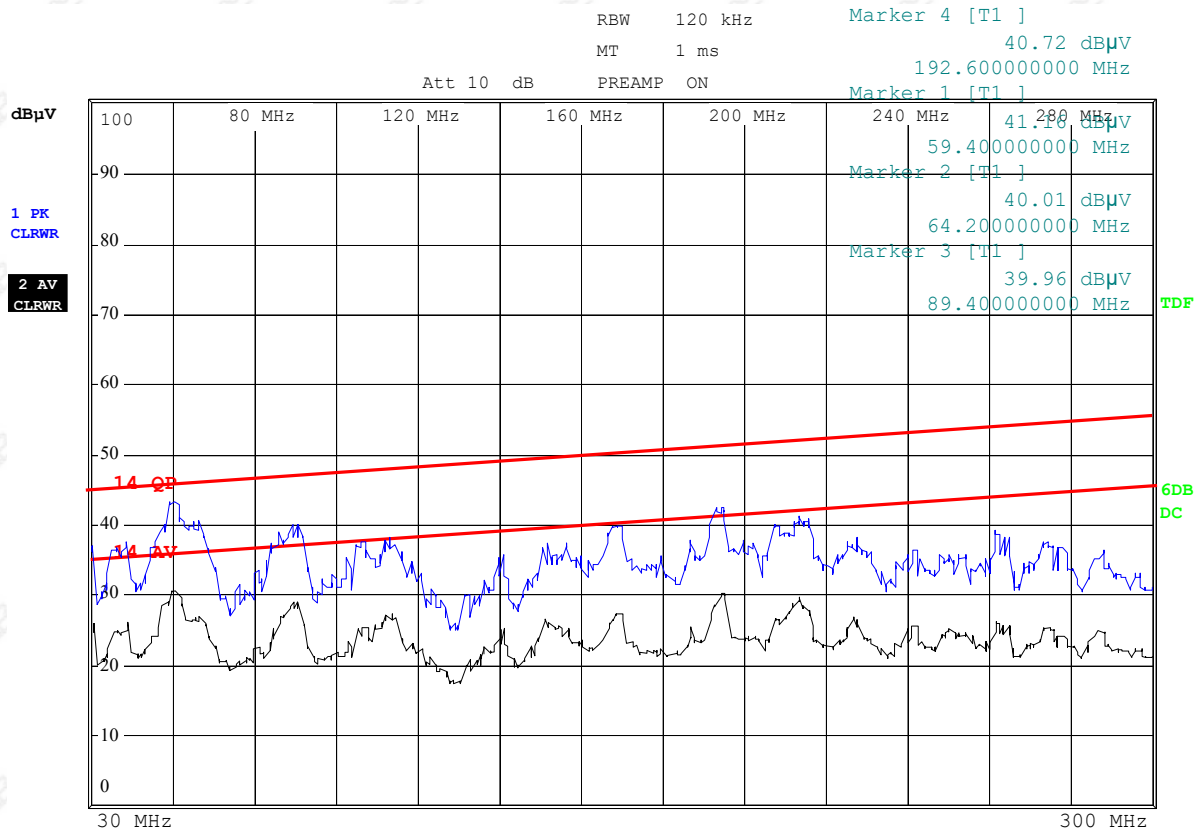

RESULT: PASS

The results shown in this test report refer only to the sample(s) tested unless otherwise stated and the sample(s) are retained for 30 days only. The document is issued by ENC, this document cannot be reproduced except in full with our prior written permission. The document is available on request and the brief information for its validation can be assessable and confirmed at <http://www.enc-lab.com>.



8. EN IEC 61000-3-2 POWER HARMONICS TEST

POWER HARMONICS MEASUREMENT

Port	: AC mains
Basic Standard	: EN IEC 61000-3-2:2019+A1:2021
Limits	: CLASS A
Tester	: Sam Liu
Temperature	: 25°C
Humidity	: 54%

8.1. TEST EQUIPMENT OF POWER HARMONICS TEST

Description	Manufacturer	Model	Identifier	Cal. Date	Cal. Due
Harmonic Emission Flicker	California instruments	500LIX-400	N/A	15/02/2023	14/02/2024

8.2. BLOCK DIAGRAM OF TEST SETUP

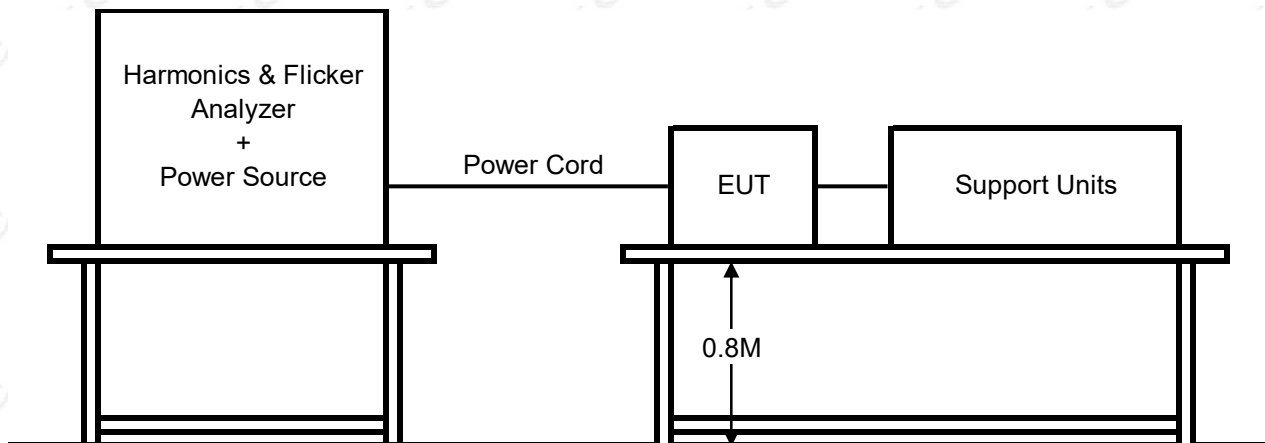

Note:

1. The EUT was tested with the equipment configured to its rated current.
2. The measurements were carried out under steady conditions. When a piece of EUT is brought into operation or is taken out of operation, manually or automatically, harmonic currents and power are not taken into account at first 10s following the switching event. EUT shall not be in standby mode for more than 10% of any observation period.
3. Harmonics of the fundamental current were measured using a digital power meter with an analogue output and frequency analyser which was integrated in the harmonic & flicker test system.
4. For each harmonic order, measure the 1,5 s smoothed r.m.s. harmonic current in each DFT time window and calculate the arithmetic average of the measured values from the DFT time windows, over the entire observation period. Each harmonic order, all 1.5 s smoothed r.m.s. harmonic current values and the average values for the individual harmonic currents, taken over the entire test observation period shall be less than or equal to the applicable limits.

The results shown in this test report refer only to the sample(s) tested unless otherwise stated and the sample(s) are retained for 30 days only. The document is issued by ENC, this document cannot be reproduced except in full with our prior written permission. The document is available on request and the brief information for its validation can be assessable and confirmed at <http://www.enc-lab.com>.

8.3. LIMITS OF HARMONIC CURRENT

Limits for Class A Equipment	
Harmonics Order n	Max. permissible harmonic current (A)
Odd harmonics	
3	2.3
5	1.14
7	0.77
9	0.40
11	0.33
13	0.21
15≤n≤39	0.15×15/n
Even harmonics	
2	1.08
4	0.43
6	0.30
8≤n≤40	0.23×8/n

NOTE:

1. According to section 5 of EN IEC 61000-3-2:2019+A1:2021, the EUT is Class A equipment.
2. The above limits are for all applications having an active input power>75W. No limits apply for equipment with an active input power up to and including 75W.

The results shown in this test report refer only to the sample(s) tested unless otherwise stated and the sample(s) are retained for 30 days only. The document is issued by ENC, this document cannot be reproduced except in full with our prior written permission. The document is available on request and the brief information for its validation can be assessable and confirmed at <http://www.enc-lab.com>.

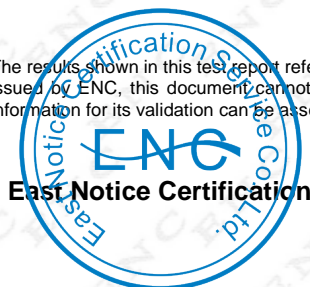

8.4. RESULT

Test Specification

Test Frequency:	50Hz	Test Voltage:	230Vac
Waveform:	Sine	Test Time:	2.5min
Classification:	Class A	Test result:	Pass

Harmonic current results

Hn	Harms(max) [A]	Limit [%]	Limit[A]	Result
1	1.801			
2	0.034	3.174	1.080	PASS
3	0.169	7.353	2.300	PASS
4	0.014	3.371	0.430	PASS
5	0.088	7.740	1.140	PASS
6	0.011	3.766	0.300	PASS
7	0.059	7.639	0.770	PASS
8	0.010	4.216	0.230	PASS
9	0.049	12.255	0.400	PASS
10	0.007	3.939	0.184	PASS
11	0.022	6.685	0.330	PASS
12	0.004	2.647	0.153	PASS
13	0.020	9.337	0.210	PASS
14	0.002	1.871	0.131	PASS
15	0.017	11.438	0.150	PASS
16	0.002	2.131	0.115	PASS
17	0.012	9.284	0.132	PASS
18	0.002	2.403	0.102	PASS
19	0.005	4.154	0.118	PASS
20	0.002	2.664	0.092	PASS
21	0.010	9.163	0.107	PASS
22	0.002	2.918	0.084	PASS
23	0.010	10.004	0.098	PASS
24	0.002	3.183	0.077	PASS
25	0.007	8.170	0.090	PASS
26	0.002	3.452	0.071	PASS
27	0.005	5.906	0.083	PASS
28	0.002	2.422	0.066	PASS
29	0.002	3.142	0.078	PASS
30	0.002	2.621	0.061	PASS
31	0.005	6.715	0.073	PASS
32	0.002	2.756	0.058	PASS
33	0.002	3.604	0.068	PASS
34	0.002	2.960	0.054	PASS
35	0.002	3.830	0.064	PASS
36	0.001	2.351	0.051	PASS
37	0.002	4.018	0.061	PASS
38	0.001	2.498	0.048	PASS
39	0.001	2.067	0.058	PASS
40	0.000	0.000	0.046	PASS

The results shown in this test report refer only to the sample(s) tested unless otherwise stated and the sample(s) are retained for 30 days only. The document is issued by ENC, this document cannot be reproduced except in full with our prior written permission. The document is available on request and the brief information for its validation can be assessable and confirmed at <http://www.enc-lab.com>.

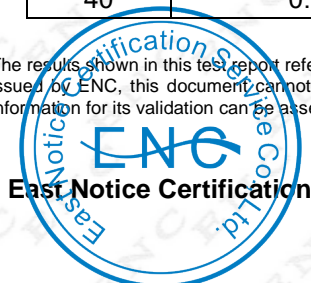

9. EN 61000-3-3 VOLTAGE FLUCTUATION / FLICKER TEST

VOLTAGE FLUCTUATION/FLICKER MEASUREMENT

Port	: AC mains
Basic Standard	: EN 61000-3-3:2013+A1:2019+A2:2021
Limits	: §5 of EN 61000-3-3
Tester	: Sam Liu
Temperature	: 25°C
Humidity	: 54%

9.1. TEST EQUIPMENT OF VOLTAGE FLUCTUATION / FLICKER TEST

Description	Manufacturer	Model	Identifier	Cal. Date	Cal. Due
Harmonic Emission Flicker	California instruments	500LIX-400	N/A	15/02/2023	14/02/2024

9.2. BLOCK DIAGRAM OF TEST SETUP

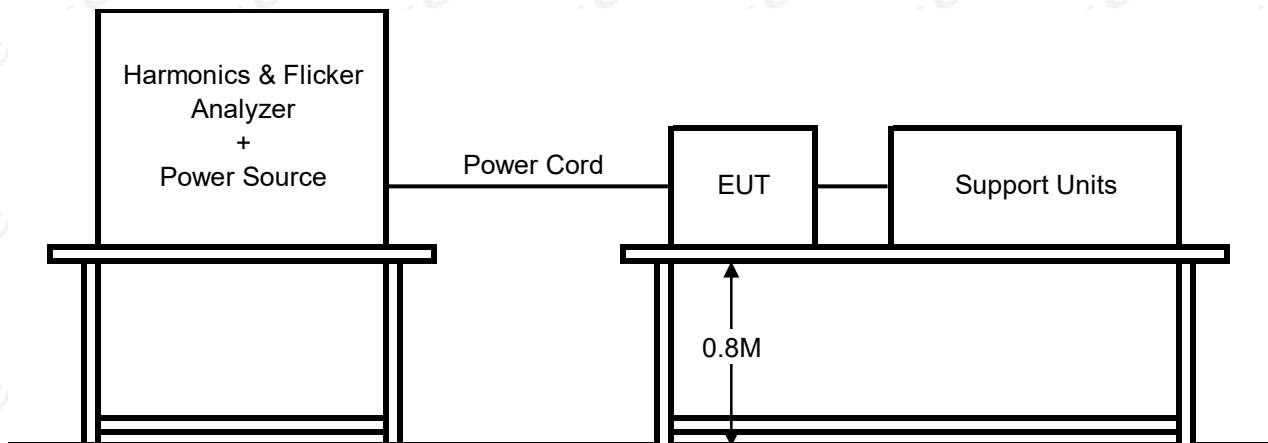

1. The test supply voltage (open-circuit voltage) was the rated voltage of the EUT. The test voltage was maintained within $\pm 2\%$ of the nominal value. The frequency was 50 Hz $\pm 0.5\%$.
2. The voltage fluctuations and flicker were measured at the supply terminals of the EUT.
3. The observation period, T_p , for the assessment of flicker values by flicker measurement, flicker simulation, or analytical method was:
 - for Pst, $T_p = 10$ min;
 - for Plt, $T_p = 2$ h.

The observation period included that part of the whole operation cycle in which the EUT produces the most unfavourable sequence of voltage changes.

The results shown in this test report refer only to the sample(s) tested unless otherwise stated and the sample(s) are retained for 30 days only. The document is issued by ENC, this document cannot be reproduced except in full with our prior written permission. The document is available on request and the brief information for its validation can be assessable and confirmed at <http://www.enc-lab.com>.



9.3. RESULT

Flicker Test Summary per EN/IEC61000-3-3 (Run time)

EUT: SOA Tested by: Sam Liu
Test category: All parameters (European limits) Test Margin: 100
Test date: 2023-04-29 Start time: 15:28:32 End time: 15:38:32
Test duration (min): 10
Comment: On
Customer: Guangzhou BBI Photoelectric Technology Co.,Ltd

Test Result: Pass

Source qualification: OK

Pst and limit line

European Limits

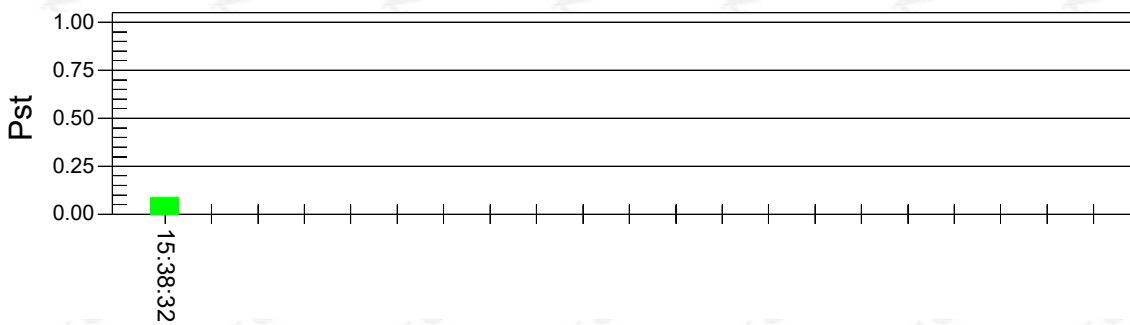

Plt and limit line

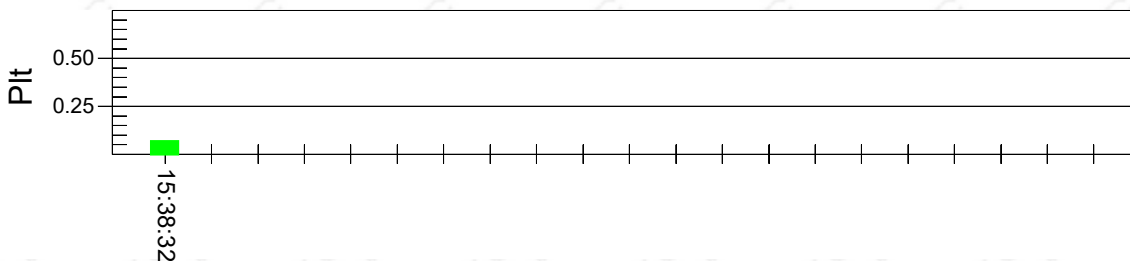

Parameter values recorded during the test:

Vrms at the end of test (Volt):	230.1			
Highest dt(%):	-0.15	Test limit (%):	3.30	Pass
Time(mS) > dt:	0.0	Test limit (mS):	500.0	Pass
Highest dc (%):	0.00	Test limit (%):	3.30	Pass
Highest dmax (%):	-0.06	Test limit (%):	4.00	Pass
Highest Pst (10 min. period):	0.096	Test limit:	1.000	Pass
Highest Plt (2 hr. period):	0.076	Test limit:	0.650	Pass

The results shown in this test report refer only to the sample(s) tested unless otherwise stated and the sample(s) are retained for 30 days only. The document is issued by ENC, this document cannot be reproduced except in full with our prior written permission. The document is available on request and the brief information for its validation can be assessable and confirmed at <http://www.enc-lab.com>.



10. IEC 61000-4-2 ESD IMMUNITY TEST ELECTROSTATIC DISCHARGE (ESD) IMMUNITY TEST

Port	: Enclosure
Basic Standard	: IEC 61000-4-2:2008
Test Level	: ±8 kV (Air Discharge) ±4 kV (Contact Discharge) ±4 kV (Indirect Discharge)
Standard require	: B
Tester	: Sam Liu
Temperature	: 25°C
Humidity	: 54%

10.1. TEST EQUIPMENT OF ESD TEST

Description	Manufacturer	Model	Identifier	Cal. Date	Cal. Due
ESD Simulator	EM-Test	EST883	N/A	15/02/2023	14/02/2024

10.2. BLOCK DIAGRAM OF TEST SETUP

(The 470 k ohm resistors are installed per standard requirement)

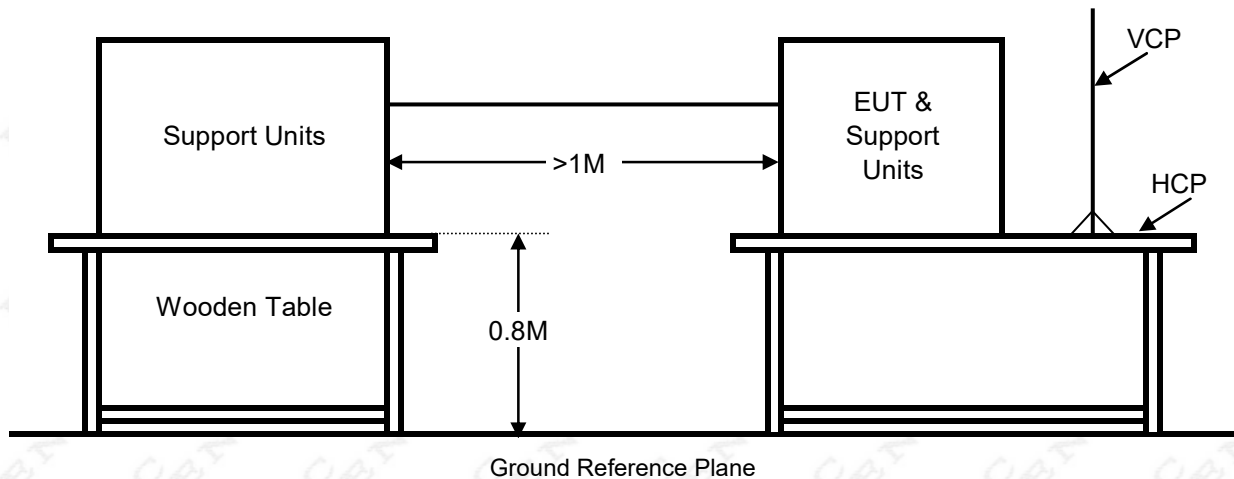

10.3. TEST PROCEDURE

The EUT was located 0.1 m minimum from all side of the HCP.

The support units were located 1 m minimum away from the EUT.

EUT worked with resistance load, and make sure EUT worked normally.

Activates the communication function if the EUT with such port(s).

As per the requirement of EN IEC 55014-2: Contact discharge is the preferred test method. 20 discharges (10 with positive and 10 negative polarity) shall be applied on each accessible metal part of the enclosure. In case of a non-conductive enclosure, discharges shall be applied on the horizontal or vertical coupling planes as specified in IEC 61000-4-2.

Air discharges shall be used where contact discharges cannot be applied.

The results shown in this test report refer only to the sample(s) tested unless otherwise stated and the sample(s) are retained for 30 days only. The document is issued by ENC, this document cannot be reproduced except in full with our prior written permission. The document is available on request and the brief information for its validation can be assessable and confirmed at <http://www.enc-lab.com>.



The following test condition was followed during the tests.

Note: As per the A2 to IEC 61000-4-2, a bleed resistor cable is connected between the EUT and HCP during the test.

The electrostatic discharges were applied as follows:

Amount of Discharges	Voltage	Coupling	Result (Pass/Fail)
Mini 20 /Point	±2kV; ±4kV	Contact Discharge	Pass
Mini 10 /Point	±2kV; ±4kV	Indirect Discharge HCP (Front)	Pass
Mini 10 /Point	±2kV; ±4kV	Indirect Discharge VCP (Left)	Pass
Mini 10 /Point	±2kV; ±4kV	Indirect Discharge VCP (Back)	Pass
Mini 10 /Point	±2kV; ±4kV	Indirect Discharge VCP (Right)	Pass
Mini 10 /Point	±2kV; ±4kV;±8kV;	Air Discharge	Pass

10.4. PERFORMANCE & RESULT

- Criteria A: The apparatus continues to operate as intended. No degradation of performance or loss of function is allowed below a performance level specified by the manufacturer, when the apparatus is used as intended. In some cases the performance level may be replaced by a permissible loss of performance.
- Criteria B: The apparatus continues to operate as intended after the test. No degradation of performance or loss of function is allowed below a performance level specified by the manufacturer, when the apparatus is used as intended. In some cases the performance level may be replaced by a permissible loss of performance. During the test, degradation of performance is however allowed.
- Criteria C: Temporary loss of function is allowed, provided the functions self recoverable or can be restored by the operation of controls.

PASS **FAIL**

The results shown in this test report refer only to the sample(s) tested unless otherwise stated and the sample(s) are retained for 30 days only. The document is issued by ENC, this document cannot be reproduced except in full with our prior written permission. The document is available on request and the brief information for its validation can be assessable and confirmed at <http://www.enc-lab.com>.

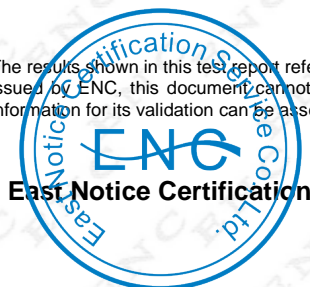

11. IEC 61000-4-3 TEST

RADIATED ELECTROMAGNETIC FIELD IMMUNITY TEST

Port : Enclosure
Basic Standard : IEC 61000-4-3:2020
Test Level : 30V/m with 80% AM. 1kHz Modulation.
Standard require : A
Tester : Sam Liu
Temperature : 25°C
Humidity : 54%

11.1. TEST EQUIPMENT

Description	Manufacturer	Model	Identifier	Cal. Date	Cal. Due
Signal Generator	IFA	2023B	N/A	15/02/2023	14/02/2024
Power Amplifier	AR	150W1000	N/A	15/02/2023	14/02/2024
Power Antenna	AR	25S1G4A	N/A	15/02/2023	14/02/2024

11.2. BLOCK DIAGRAM OF TEST SETUP

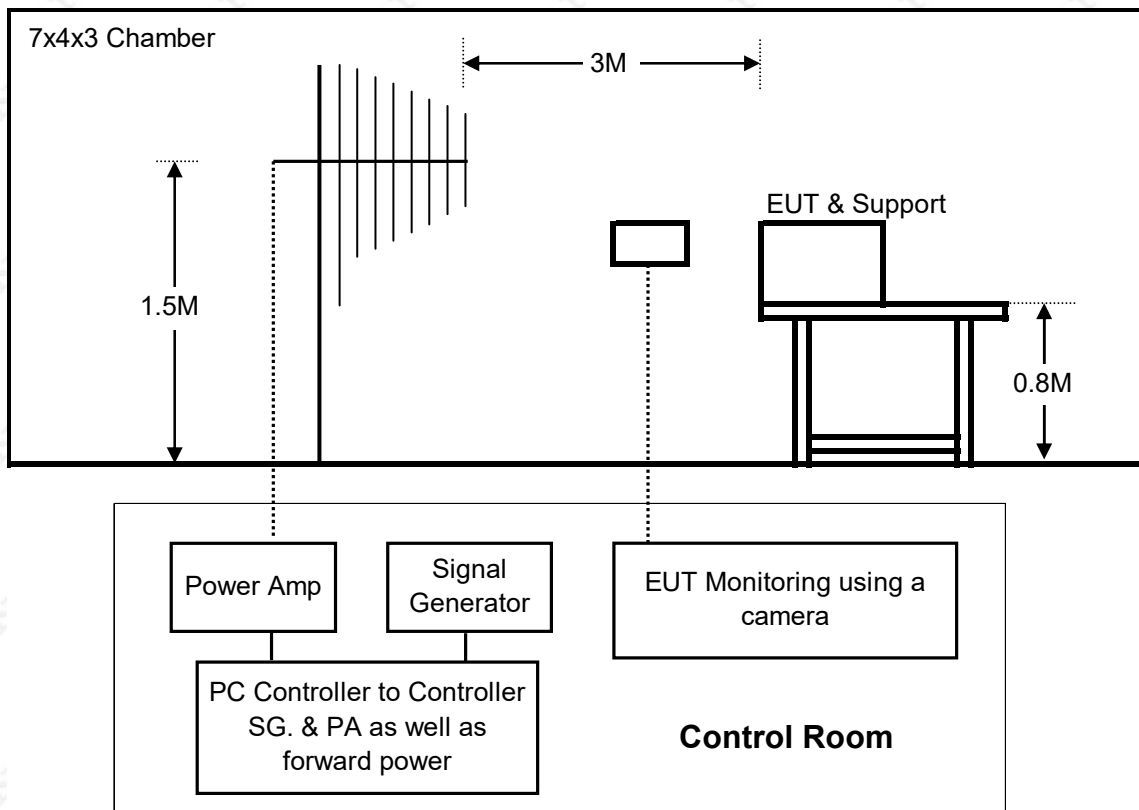

The results shown in this test report refer only to the sample(s) tested unless otherwise stated and the sample(s) are retained for 30 days only. The document is issued by ENC, this document cannot be reproduced except in full with our prior written permission. The document is available on request and the brief information for its validation can be assessable and confirmed at <http://www.enc-lab.com>.

11.3. TEST PROCEDURE

The EUT was located at the edge of supporting table keep 3 meter away from transmitting antenna, it just the calibrated square area of field uniformity. The support units were located outside of the uniformity area, but the cable(s) connected with EUT were exposed to the calibrated field as per IEC 61000-4-3.

EUT worked with resistance load, and make sure EUT worked normally.

Setting the testing parameters of RS test software per IEC 61000-4-3. Performing the test at each side of with specified level (30V/m) at 1% steps and test frequency from 80MHz to 2700MHz.

Recording the test result in following table.

It is not necessary to perform test as per annex A of EN IEC 55014-2 if the EUT doesn't belong to TTE product.

IEC 61000-4-3 Final test conditions:

Test level : 30V/m
Steps : 1 % of fundamental
Dwell Time : 1 sec

Range (MHz)	Field	Modulation	Polarity	Position	Result (Pass/Fail)
80-2700	30V/m	AM	H	Front	Pass
80-2700	30V/m	AM	H	Left	Pass
80-2700	30V/m	AM	H	Back	Pass
80-2700	30V/m	AM	H	Right	Pass
80-2700	30V/m	AM	V	Front	Pass
80-2700	30V/m	AM	V	Left	Pass
80-2700	30V/m	AM	V	Back	Pass
80-2700	30V/m	AM	V	Right	Pass

11.4. PERFORMANCE & RESULT

- Criteria A: The apparatus continues to operate as intended. No degradation of performance or loss of function is allowed below a performance level specified by the manufacturer, when the apparatus is used as intended. In some cases the performance level may be replaced by a permissible loss of performance.
- Criteria B: The apparatus continues to operate as intended after the test. No degradation of performance or loss of function is allowed below a performance level specified by the manufacturer, when the apparatus is used as intended. In some cases the performance level may be replaced by a permissible loss of performance. During the test, degradation of performance is however allowed.
- Criteria C: Temporary loss of function is allowed, provided the functions self recoverable or can be restored by the operation of controls.

PASS **FAIL**

The results shown in this test report refer only to the sample(s) tested unless otherwise stated and the sample(s) are retained for 30 days only. The document is issued by ENC, this document cannot be reproduced except in full with our prior written permission. The document is available on request and the brief information for its validation can be assessable and confirmed at <http://www.enc-lab.com>.



12. IEC 61000-4-4 TEST

ELECTRICAL FAST TRANSIENTS/BURST IMMUNITY TEST

Port : On Power Supply Lines
Basic Standard : IEC 61000-4-4:2012
Test Level : +/- 1kV for Power Supply Lines
Standard require : B
Tester : Sam Liu
Temperature : 25°C
Humidity : 54%

12.1. TEST EQUIPMENT

Description	Manufacturer	Model	Identifier	Cal. Date	Cal. Due
Compact Generator	EM-Test	UCS500M	N/A	15/02/2023	14/02/2024
Capacitive Clamp	EM-Test	HY21-EFTC	N/A	15/02/2023	14/02/2024
CDN for Telecom Port	EM-Test	CNV504S1	N/A	15/02/2023	14/02/2024

12.2. BLOCK DIAGRAM OF TEST SETUP

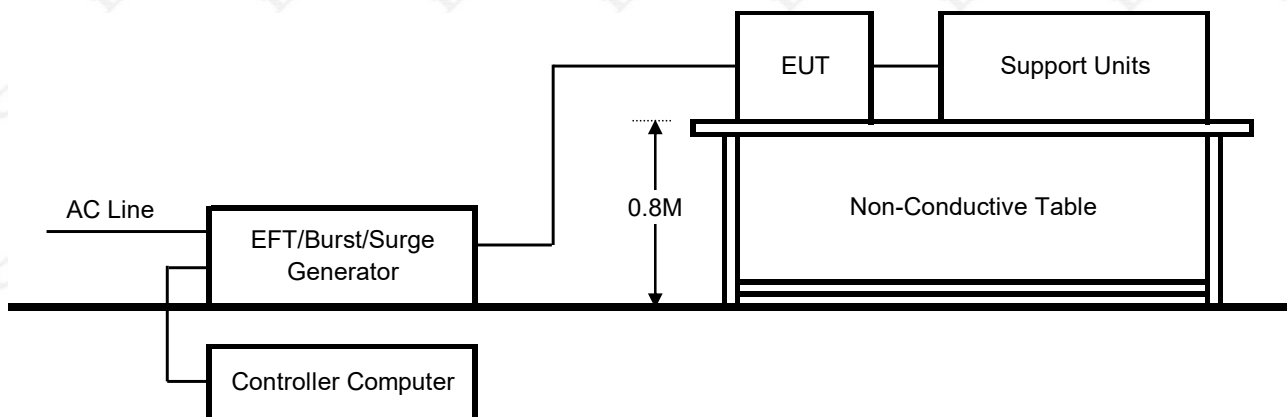

The results shown in this test report refer only to the sample(s) tested unless otherwise stated and the sample(s) are retained for 30 days only. The document is issued by ENC, this document cannot be reproduced except in full with our prior written permission. The document is available on request and the brief information for its validation can be assessable and confirmed at <http://www.enc-lab.com>.

12.3. TEST PROCEDURE

The EUT and support units were located on a wooden table 0.8m away from ground reference plane.

A 1.0 meter long power cord was attached to EUT during the test.

The length of communication cable between communication port and clamp was keeping within 1 meter.

EUT worked with resistance load, and make sure EUT worked normally.

Related peripherals work during the test.

Recording the test result as shown in following table.

Test conditions:

Impulse Frequency: 5 kHz

Tr/Th: 5/50ns

Burst Duration: 15ms

Burst Period: 300ms

Inject Line	Voltage kV	Inject Method	Result (Pass/Fail)
L	+ /- 0.5/1	Direct	Pass
N	+ /- 0.5/1	Direct	Pass
PE	+ /- 0.5/1	Direct	Pass
L+N	+ /- 0.5/1	Direct	Pass
N+PE	+ /- 0.5/1	Direct	Pass
L+N+PE	+ /- 0.5/1	Direct	Pass

12.4. PERFORMANCE & RESULT

Criteria A: The apparatus continues to operate as intended. No degradation of performance or loss of function is allowed below a performance level specified by the manufacturer, when the apparatus is used as intended. In some cases the performance level may be replaced by a permissible loss of performance.

Criteria B: The apparatus continues to operate as intended after the test. No degradation of performance or loss of function is allowed below a performance level specified by the manufacturer, when the apparatus is used as intended. In some cases the performance level may be replaced by a permissible loss of performance. During the test, degradation of performance is however allowed.

Criteria C: Temporary loss of function is allowed, provided the functions self recoverable or can be restored by the operation of controls.

PASS

FAIL

The results shown in this test report refer only to the sample(s) tested unless otherwise stated and the sample(s) are retained for 30 days only. The document is issued by ENC, this document cannot be reproduced except in full with our prior written permission. The document is available on request and the brief information for its validation can be assessable and confirmed at <http://www.enc-lab.com>.

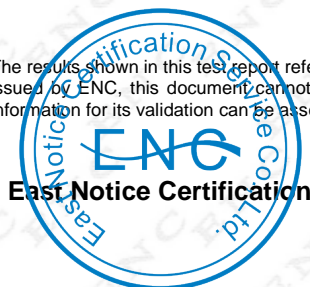

13. IEC 61000-4-5 SURGE IMMUNITY TEST

SURGE IMMUNITY TEST

Port : On Power Supply Lines
Basic Standard : IEC 61000-4-5:2017
Requirements : +/- 1kV (Line to Line)
 : +/- 2kV (Line to Ground)
Standard require : B
Tester : Sam Liu
Temperature : 25°C
Humidity : 54%

13.1. TEST EQUIPMENT OF SURGE TEST

Description	Manufacturer	Model	Identifier	Cal. Date	Cal. Due
Compact Generator	EM-Test	UCS500M	N/A	15/02/2023	14/02/2024
Capacitive Clamp	EM-Test	HY21-EFTC	N/A	15/02/2023	14/02/2024
CDN for Telecom Port	EM-Test	CNV504S1	N/A	15/02/2023	14/02/2024

13.2. BLOCK DIAGRAM OF TEST SETUP

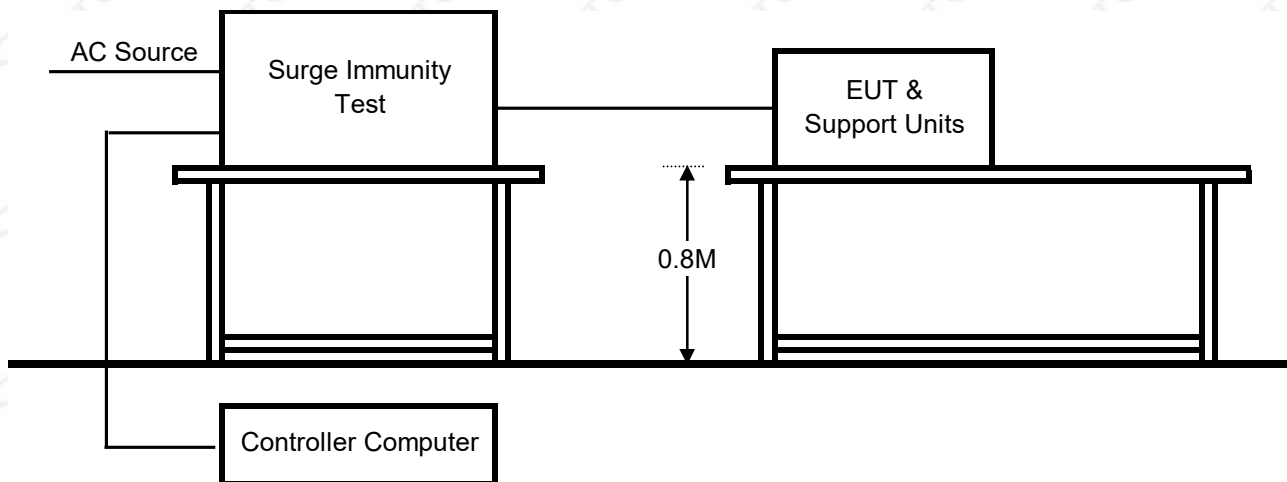

The results shown in this test report refer only to the sample(s) tested unless otherwise stated and the sample(s) are retained for 30 days only. The document is issued by ENC, this document cannot be reproduced except in full with our prior written permission. The document is available on request and the brief information for its validation can be assessable and confirmed at <http://www.enc-lab.com>.

13.3. TEST PROCEDURE

The EUT and support units were located on a wooden table 0.8 m away from ground floor.

EUT worked with resistance load, and make sure EUT worked normally.

Recording the test result as shown in following table.

Test conditions:

Voltage Waveform : 1.2/50 us
Current Waveform : 8/20 us
Polarity : Positive/Negative
Phase angle : 0°, 90°, 270°
Number of Test : 5

Coupling Line	Voltage (kV)	Polarity	Coupling Method	Result (Pass/Fail)
L1-L2	1	Positive	Capacitive	Pass
L1-L2	1	Negative	Capacitive	Pass
L1-PE	2	Positive	Capacitive	Pass
L1-PE	2	Negative	Capacitive	Pass
L2-PE	2	Positive	Capacitive	Pass
L2-PE	2	Negative	Capacitive	Pass

13.4. PERFORMANCE & RESULT

Criteria A: The apparatus continues to operate as intended. No degradation of performance or loss of function is allowed below a performance level specified by the manufacturer, when the apparatus is used as intended. In some cases the performance level may be replaced by a permissible loss of performance.

Criteria B: The apparatus continues to operate as intended after the test. No degradation of performance or loss of function is allowed below a performance level specified by the manufacturer, when the apparatus is used as intended. In some cases the performance level may be replaced by a permissible loss of performance. During the test, degradation of performance is however allowed.

Criteria C: Temporary loss of function is allowed, provided the functions self recoverable or can be restored by the operation of controls.

PASS **FAIL**

The results shown in this test report refer only to the sample(s) tested unless otherwise stated and the sample(s) are retained for 30 days only. The document is issued by ENC, this document cannot be reproduced except in full with our prior written permission. The document is available on request and the brief information for its validation can be assessable and confirmed at <http://www.enc-lab.com>.

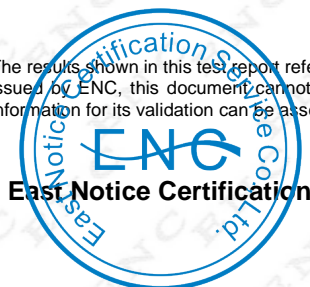

14. IEC 61000-4-6 TEST

IEC 61000-4-6 IMMUNITY TO CONDUCTED DISTURBANCES, INDUCED BY RADIO-FREQUENCY FIELD

Port	:	Power Supply Lines
Basic Standard	:	IEC 61000-4-6:2013
Requirements	:	3V with 80% AM. 1 kHz Modulation
Standard require	:	A
Tester	:	Sam Liu
Temperature	:	25°C
Humidity	:	54%

14.1. TEST EQUIPMENT

Description	Manufacturer	Model	Identifier	Cal. Date	Cal. Due
Power Amplifier	AR	150W1000	N/A	15/02/2023	14/02/2024
CDN	EM-Test	CNV504S1	N/A	15/02/2023	14/02/2024
Direction Coupler	EM-Test	DC2600N	N/A	15/02/2023	14/02/2024
EM-Clamp	EM-Test	EM101	N/A	15/02/2023	14/02/2024
Caliberation	EM-Test	CAM2/M3	N/A	15/02/2023	14/02/2024
Attenuator	EM-Test	ATT6/75	N/A	15/02/2023	14/02/2024
Power Sensor	AR	PH2000	N/A	15/02/2023	14/02/2024
Power Meter	AR	PM2002	N/A	15/02/2023	14/02/2024
Signal Generator	IFA	2023A	N/A	15/02/2023	14/02/2024

14.2. BLOCK DIAGRAM OF TEST SETUP

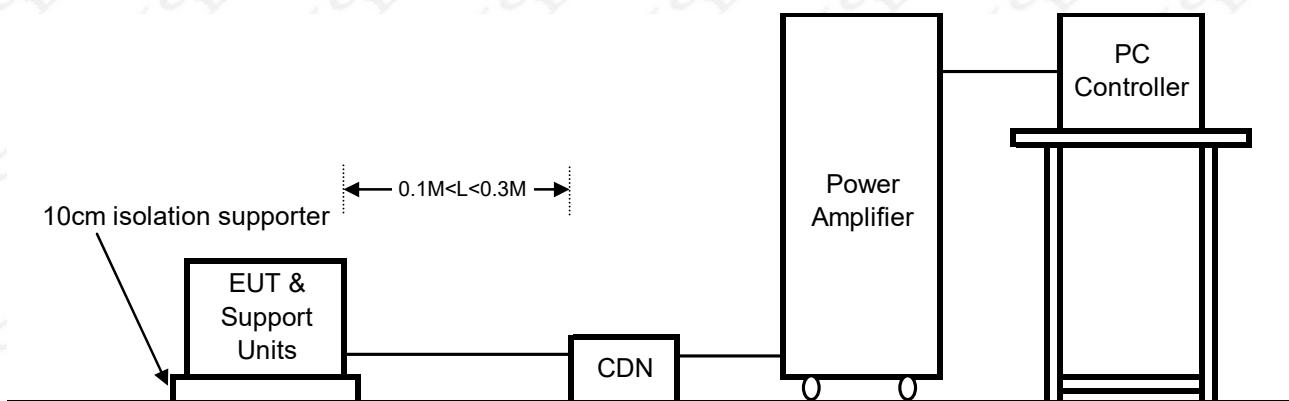

The results shown in this test report refer only to the sample(s) tested unless otherwise stated and the sample(s) are retained for 30 days only. The document is issued by ENC, this document cannot be reproduced except in full with our prior written permission. The document is available on request and the brief information for its validation can be assessable and confirmed at <http://www.enc-lab.com>.

14.3. TEST PROCEDURE

The EUT and support units were located at a ground reference plane with the interposition of a 0.1 m thickness insulating support and the CDN was located on GRP directly.

EUT worked with resistance load, and make sure EUT worked normally.

Related peripherals work during the test.

Setting the testing parameters of CS test software per IEC 61000-4-6.

Recording the test result in following table.

Test conditions:

Frequency Range: 0.15MHz-230MHz

Frequency Step: 1% of fundamental

Dwell Time: 1 sec

Range (MHz)	Strength	Modulation	Result (Pass/Fail)
0.15-230	3V	AM	Pass

14.4. PERFORMANCE & RESULT

Criteria A: The apparatus continues to operate as intended. No degradation of performance or loss of function is allowed below a performance level specified by the manufacturer, when the apparatus is used as intended. In some cases the performance level may be replaced by a permissible loss of performance.

Criteria B: The apparatus continues to operate as intended after the test. No degradation of performance or loss of function is allowed below a performance level specified by the manufacturer, when the apparatus is used as intended. In some cases the performance level may be replaced by a permissible loss of performance. During the test, degradation of performance is however allowed.

Criteria C: Temporary loss of function is allowed, provided the functions self recoverable or can be restored by the operation of controls.

PASS **FAIL**

The results shown in this test report refer only to the sample(s) tested unless otherwise stated and the sample(s) are retained for 30 days only. The document is issued by ENC, this document cannot be reproduced except in full with our prior written permission. The document is available on request and the brief information for its validation can be assessable and confirmed at <http://www.enc-lab.com>.

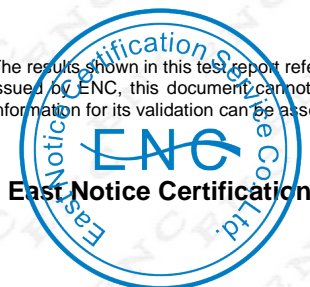

15. IEC 61000-4-11 TEST

VOLTAGE DIPS, SHORT INTERRUPTIONS AND VOLTAGE VARIATIONS IMMUNITY TEST

Port : Power Supply Lines
Basic Standard : IEC 61000-4-11:2020
Requirements : 0, 45, 90, 135, 180, 225, 270, 315 degrees
Standard require : Min. 10 sec.
Test Interval: : Sam Liu
Temperature : 25°C
Humidity : 54%

Voltage Dips	Test Level	Reduction	Duration	Performance
	% U_T	(%)	(periods)	Criteria
	40	60	10	C
70	30	25	C	

Voltage Interruptions	Test Level	Reduction	Duration	Performance
	% U_T	(%)	(periods)	Criteria
0	100	0.5	C	

15.1. TEST EQUIPMENT

Description	Manufacturer	Model	Identifier	Cal. Date	Cal. Due
Compact Generator	EM-Test	UCS500M	N/A	15/02/2023	14/02/2024
Capacitive Clamp	EM-Test	HY21-EFTC	N/A	15/02/2023	14/02/2024
CDN for Telecom Port	EM-Test	CNV504S1	N/A	15/02/2023	14/02/2024

15.2. BLOCK DIAGRAM OF TEST SETUP

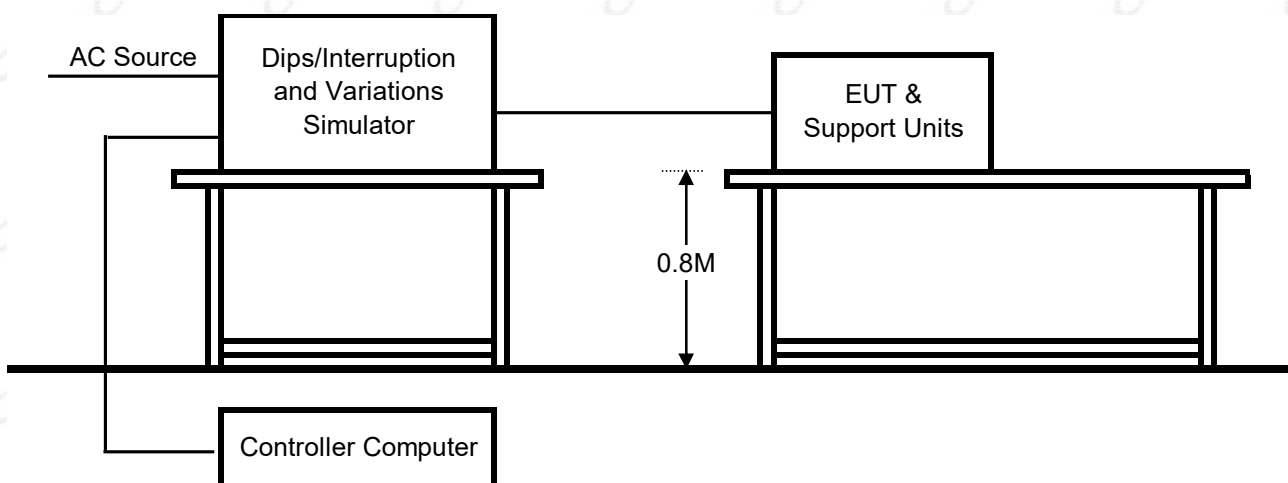

The results shown in this test report refer only to the sample(s) tested unless otherwise stated and the sample(s) are retained for 30 days only. The document is issued by ENC, this document cannot be reproduced except in full with our prior written permission. The document is available on request and the brief information for its validation can be assessable and confirmed at <http://www.enc-lab.com>.

15.3. TEST PROCEDURE

The EUT and support units were located on a wooden table, 0.8 m away from ground floor. EUT worked with resistance load, and make sure EUT worked normally.

Setting the parameter of tests and then perform the test software of test simulator.

Conditions changes to occur at 0 degree crossover point of the voltage waveform.

Recording the test result in test record form.

Test conditions:

The duration with a sequence of three dips/interruptions with interval of 10 s minimum

(Between each test event)

Voltage Dips:

Test Level % U _T	Reduction (%)	Duration (periods)	Observation	Meet Performance Criteria
40	60	10	Normal	C
70	30	25	Normal	C

Voltage Interruptions:

Test Level % U _T	Reduction (%)	Duration (periods)	Observation	Meet Performance Criteria
0	100	0.5	Normal	C

15.4. PERFORMANCE

Criteria A: The apparatus continues to operate as intended. No degradation of performance or loss of function is allowed below a performance level specified by the manufacturer, when the apparatus is used as intended. In some cases the performance level may be replaced by a permissible loss of performance.

Criteria B: The apparatus continues to operate as intended after the test. No degradation of performance or loss of function is allowed below a performance level specified by the manufacturer, when the apparatus is used as intended. In some cases the performance level may be replaced by a permissible loss of performance. During the test, degradation of performance is however allowed.

Criteria C: Temporary loss of function is allowed, provided the functions self recoverable or can be restored by the operation of controls.

PASS **FAIL**

The results shown in this test report refer only to the sample(s) tested unless otherwise stated and the sample(s) are retained for 30 days only. The document is issued by ENC, this document cannot be reproduced except in full with our prior written permission. The document is available on request and the brief information for its validation can be assessable and confirmed at <http://www.enc-lab.com>.

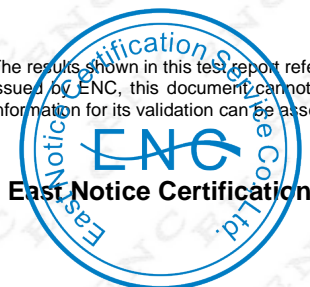

APPENDIX 1 PHOTOGRAPHS OF EUT

Front View



Back View



The results shown in this test report refer only to the sample(s) tested unless otherwise stated and the sample(s) are retained for 30 days only. The document is issued by ENC, this document cannot be reproduced except in full with our prior written permission. The document is available on request and the brief information for its validation can be assessable and confirmed at <http://www.enc-lab.com>.

Left View

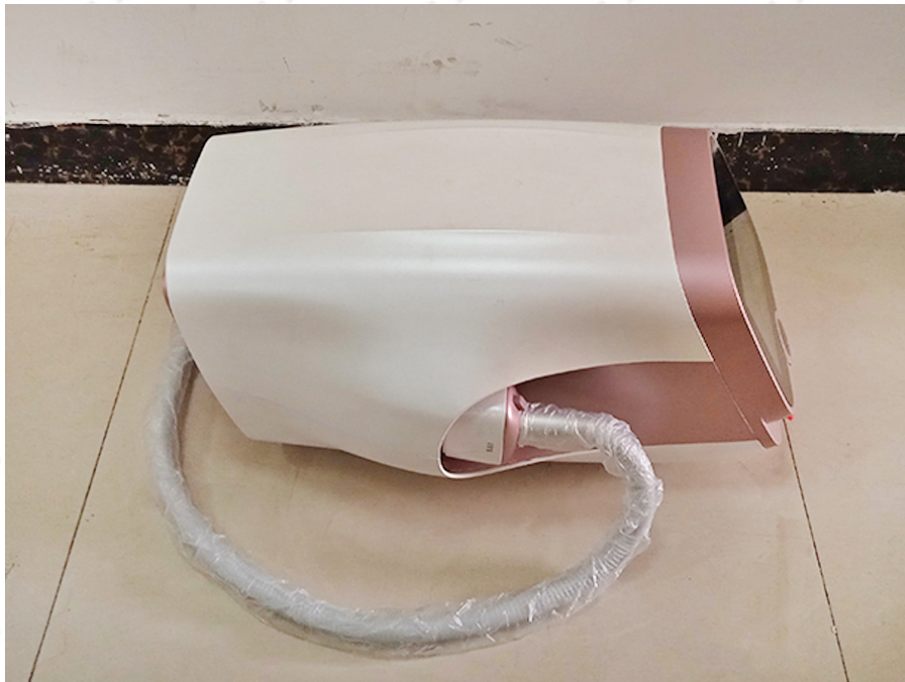

Right View



----END OF REPORT----

The results shown in this test report refer only to the sample(s) tested unless otherwise stated and the sample(s) are retained for 30 days only. The document is issued by ENC, this document cannot be reproduced except in full with our prior written permission. The document is available on request and the brief information for its validation can be assessable and confirmed at <http://www.enc-lab.com>.

